



Job or Customer :	
Location :	
Engineer :	
<input checked="" type="checkbox"/> Complies with Spec	Notes :
<input checked="" type="checkbox"/> Alternate	
Contractor :	
Tamas Rep :	
Submitted By :	Date :
Approved By :	Date :
P.O. Number :	Date :

Description

The Tamas Snowmelt Panel, in conjunction with the snowmelt control, socket, and sensor, utilizes optics rather than continuity based on/ off sensors. This method of snowmelt detection allows for great efficiencies and set point controllability.

The control on the panel measures slab temperature, as well as boiler loop temperature to ensure the return water going back to the boiler does not shock the boiler heat exchanger.

The snowmelt system pump is piped independently from the boiler loop so that the only head loss that needs to be calculated in the system is the piping from the panel to the manifold, and the loops in the slab. This feature allows for higher flow rates and head losses if needed, which in turn expands the range of pumping ability for the system pump.

Nominal Panel Output

Qty	Model #	BTU Rating	Boiler Pump	System Pump	Injection Pump	Heat Exchanger	Snow Melt Control
	T-SM-HBX-400 HX	400 000	UPS 26-99	UPS 26-150	UPS 26-99	LB31-40	HBX SNO-0600

Technical Data

Material:	
Backpan.....	Galvanized Steel
Optional Lockable Enclosure.....	Powder Coated Steel
Piping.....	Stainless Steel
Mixing Device.....	Injection Pump
Max Ambient Temperature.....	120°F (49°C)
Max Water Temperature.....	200°F (93°C)
Power Supply.....	120V (AC) Max Current 15amp

Standards/Listings

- CSA C22.2 No. 14-95
- UL 598A
- ETL No. 3032227

PROJECT DATA SHEET

Heat Load	400 000 BTU/h	
LMTD	61.9 deg. F	
Min. Oversizing	0 %	
	Hot Side	Cold Side
Fluid	water	glycol_(propylene)_50%
Inlet Temperature	185.00 deg. F	69.00 deg. F
Outlet Temperature	150.00 deg. F	139.00 deg. F
Mass Flow	11430.41 lb/h	6525.96 lb/h
Inlet Volume Flow	23.54 USGal/min	12.55 USGal/min
Outlet Volume Flow	23.24 USGal/min	12.89 USGal/min
Max. Pressure Drop	14.50 psi	14.50 psi

HEAT EXCHANGER SELECTION

Heat Exchanger Type	LB31 - 40	
# of Units Parallel	1.00	
Heat Transfer Area	13.6 ft ²	
Fouling Factor	0.0005 ft ² hf/BTU	
OHTC Clean	699.4 BTU/ft ² hf	
OHTC Fouling	510.2 BTU/ft ² hf	
Oversize	37.1 %	
	Hot Side	Cold Side
Calculated Pressure Drop	5.24 psi	2.48 psi
Heat Transfer NTU	-	-

PHYSICAL PROPERTIES

	Hot Side	Cold Side
Fluid	water	glycol_(propylene)_50%
Pressure	30.0 psig	30.0 psig
Reference Temperature	167.5 deg. F	104.0 deg. F
Density	60.961 lb/ft ³	63.989 lb/ft ³
Heat Capacity	1.0 BTU/lbF	0.876 BTU/lbF
Thermal Conductivity	0.38 BTU/ft ^h F	0.218 BTU/ft ^h F
Dynamic Viscosity	0.381 cP	2.792 cP

Dimensions: mm (inches), NP = 'Number of Plates'

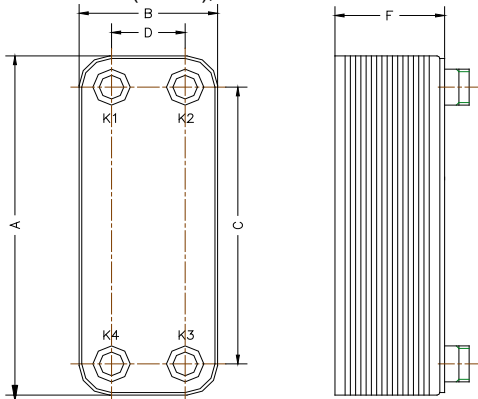

A	B	C	D	F	K1	K2	K3	K4
306 (12.0)	126 (5.0)	248.9(9.8)	69.9(2.75)	12.4 + 2.4NP(0.49+ 0.09NP)	1"	1"	1"	1"

Specifications and dimensional data shall be used as guidelines and may change without notice.
 For guaranteed performance, please verify selections with the manufacturer.

4516 112 Ave S.E. Calgary, Alberta • Tel: (403) 279 0020 • Fax: (403) 279 0747

Panel Components

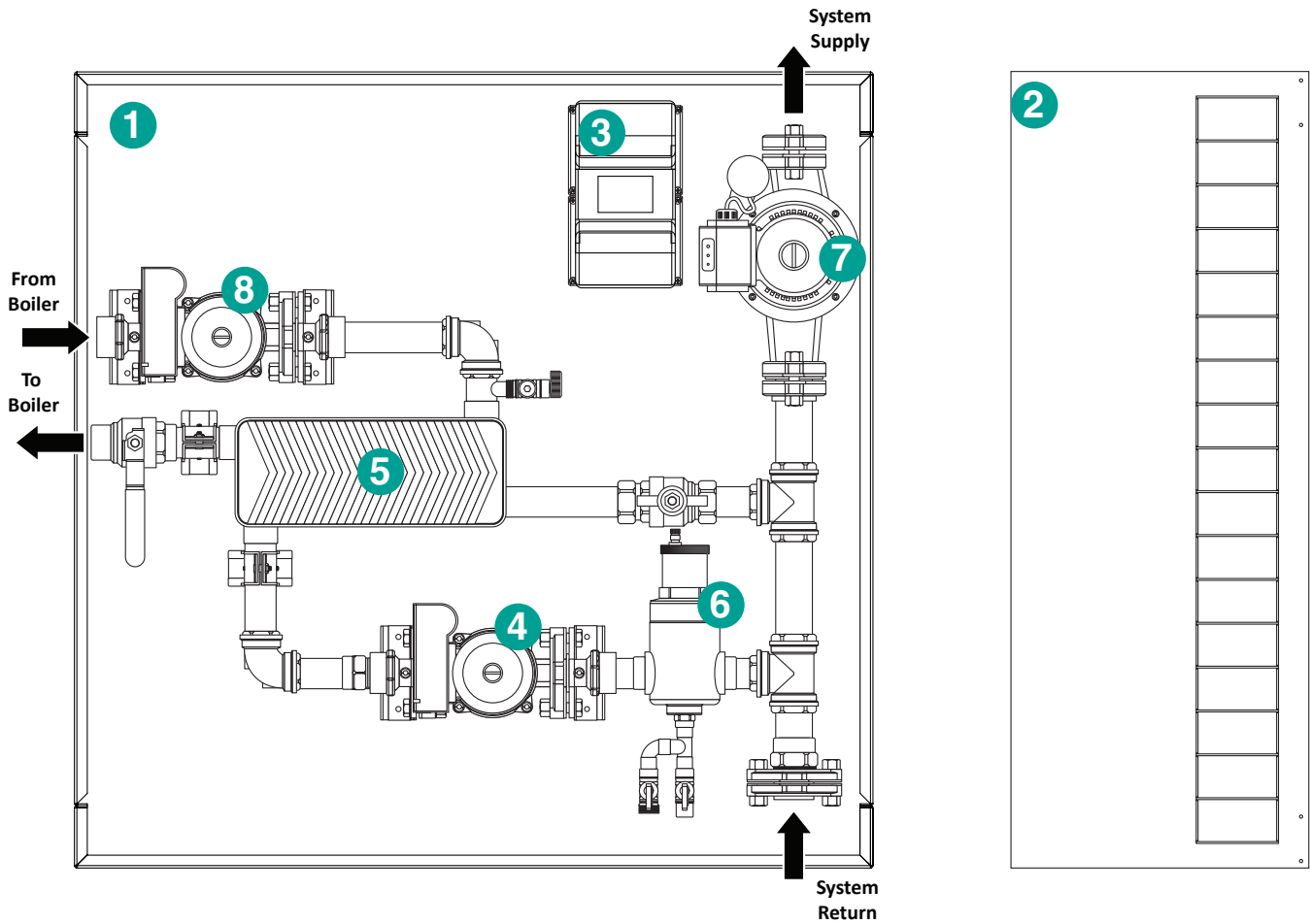

Part List

1	<i>Galvanized Steel Back Plate</i>	5	<i>Brazed Plate Heat Exchanger</i>
2	<i>Lockable Powder Coated Steel Cover (Optional)</i>	6	<i>1^{1/4}" Air Eliminator</i>
3	<i>HBX SNO-0600 Snow Melt Control</i>	7	<i>System Pump</i>
4	<i>Injection Pump</i>	8	<i>Boiler Pump</i>

Panel Dimensions

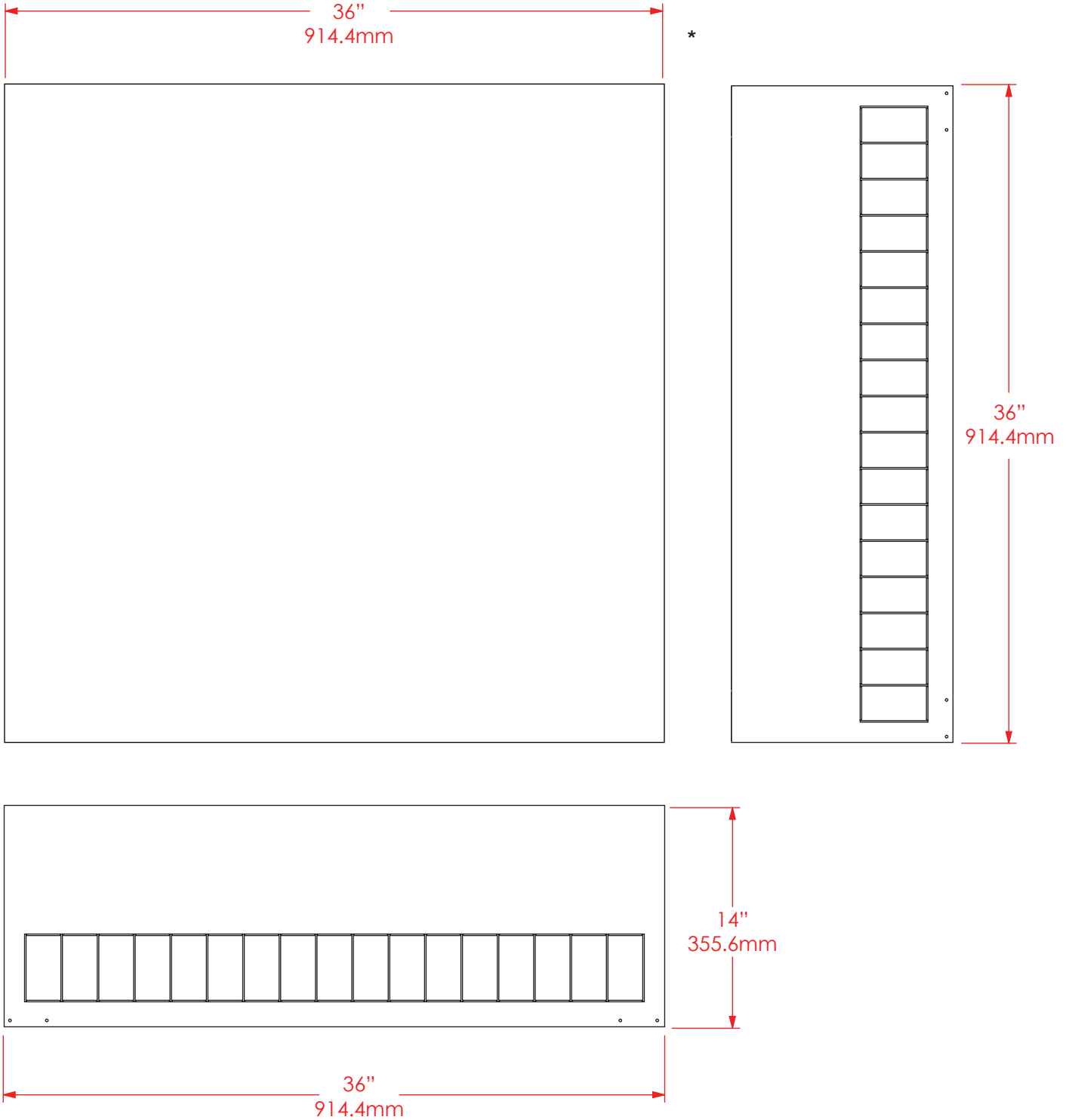

*Optional Lockable Enclosure Shown

UPS 26-99FC/BFC SUPERBRUTE

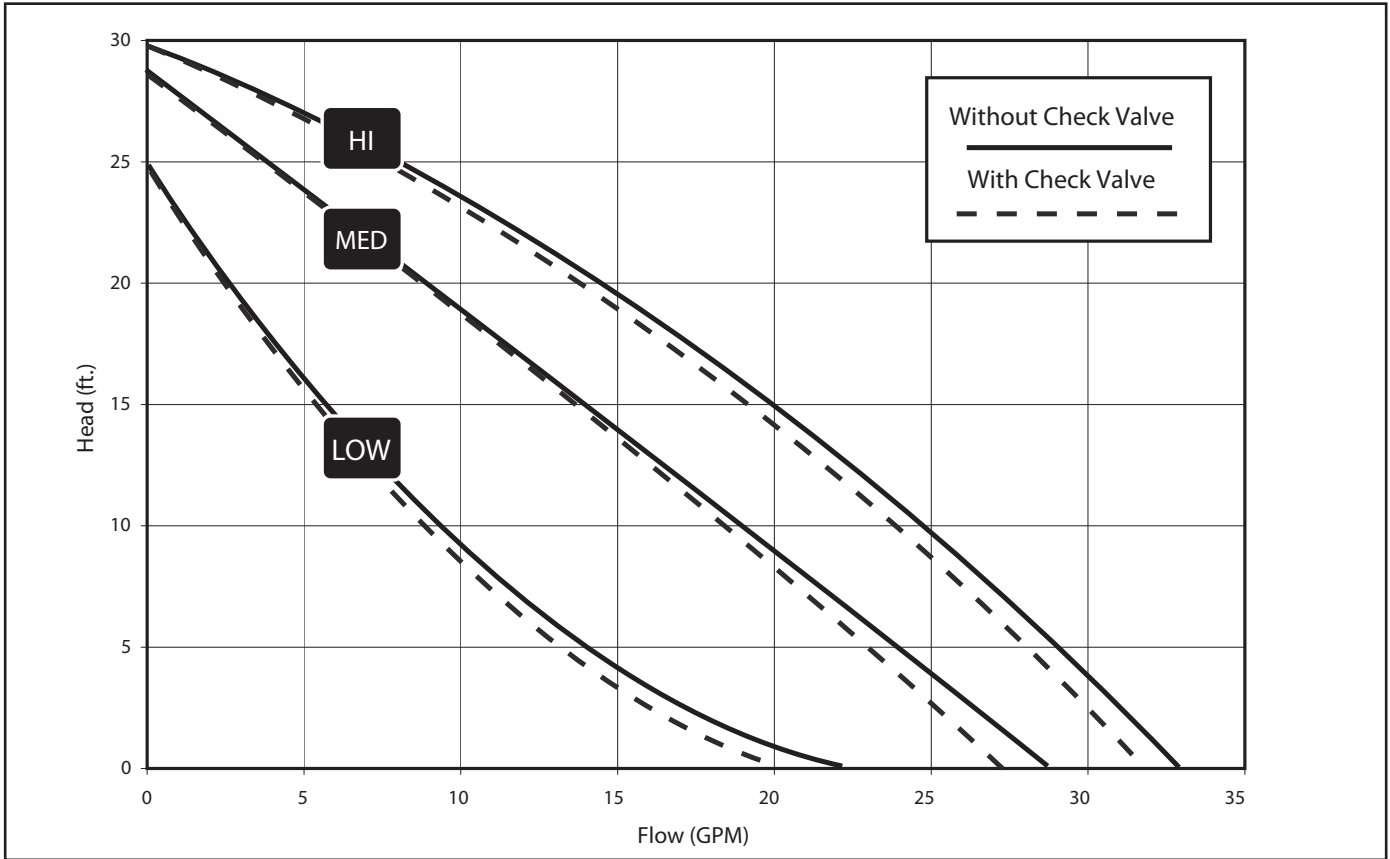

Flow range: 0 - 34 U.S. GPM
 Head range: 0 - 30 FEET
 Motors: 2 Pole, Single Phase
 Maximum fluid temperature: 230°F (110°C)
 Min. fluid temperature: 36°F (2°C)
 Maximum working pressure: 145 PSI

MODEL	VOLTS	AMPS	WATTS	HP	CAPACITOR
115V	Spd. 3	1.8	197	1/6	20mF/180V
	Spd. 2	1.5	179	1/6	20mF/180V
	Spd. 1	1.3	150	1/6	20mF/180V
230V	Spd. 3	0.9	196	1/6	5mF/400V
	Spd. 2	0.8	179	1/6	5mF/400V
	Spd. 1	0.7	150	1/6	5mF/400V

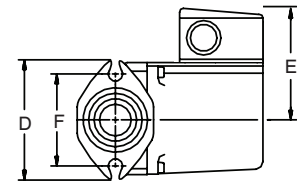
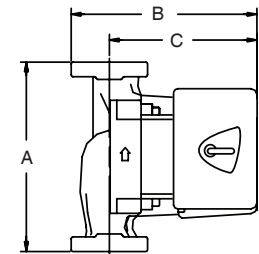

Model Type	A	B	C	D	E	F	Connection Type and Size	Approximate Shipping Wt. (lbs)
UPS26-99FC/BFC	6 1/2	6	4 7/8	3 1/2	3 7/16	3 5/32	GF 15/26 Flange - (2) 1/2" Dia. Bolt Holes	10.3

95906630 UPS 26-150 F 60 Hz

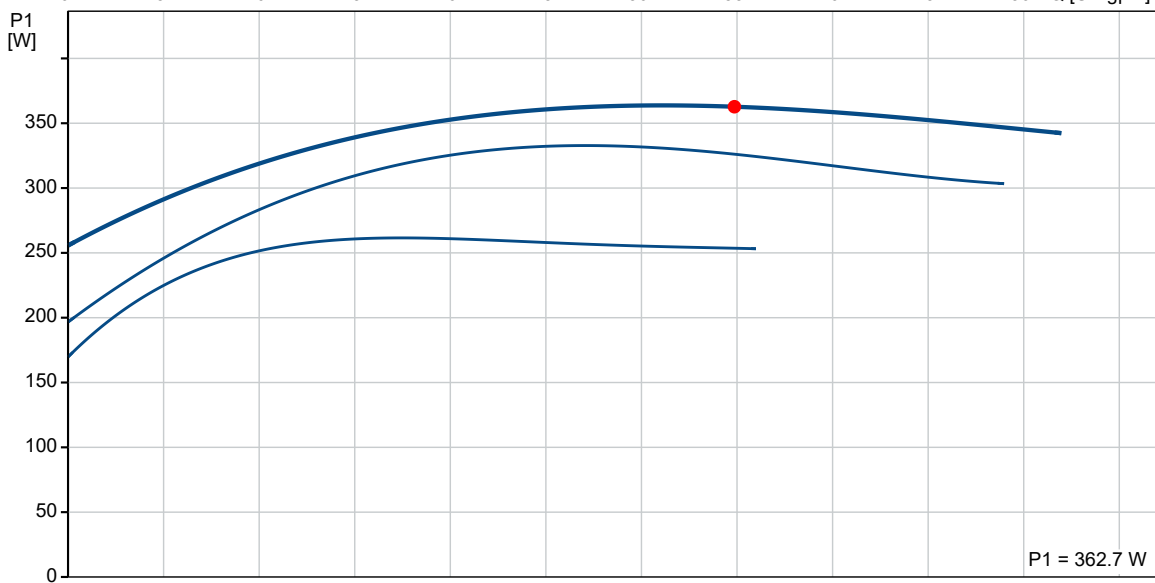
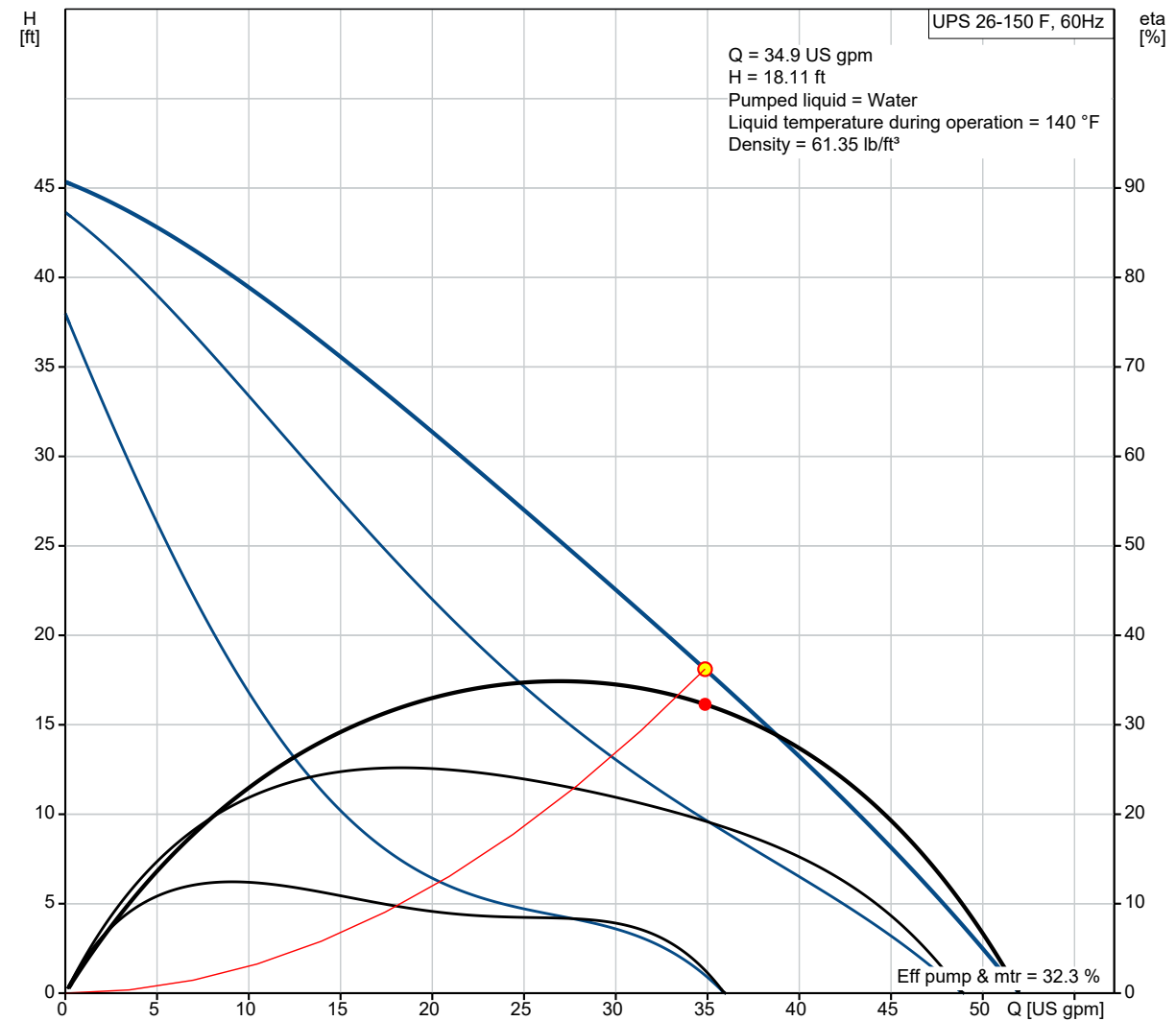

HBX SNO-0600 Control

Inputs/Outputs:

- 4 x Thermistor Input (10K Ohm)
- 1x Modulating Output (0-10VDC)
- 1 x Boiler/BMS Dry Contact (24 VAC, 2A) Output
- *(One future relay) 3 x
- AUX Relay Dry Contact (240VAC, 5A) Outputs
- 2 x Dry Contact Demand Input
- 2x Dry Contact Demand Output

Sensor Input:

- 1 x Optical Snow & Ice Detector / Slab Sensor Input
- 1 x Modulating Heater Output

Power supply:

- 120 VAC, 15A (protected by resettable fuse)

Supplied Parts:

- 1 x HBX 029-0022 – 10K Ohm Thermistor, 12” lead wire
- 1 x HBX OUT-0100 – 10K Ohm Outdoor Sensor
- 2 x Cable ties
- 1 x Terminal screwdriver (2.5mm)



DIMENSIONS

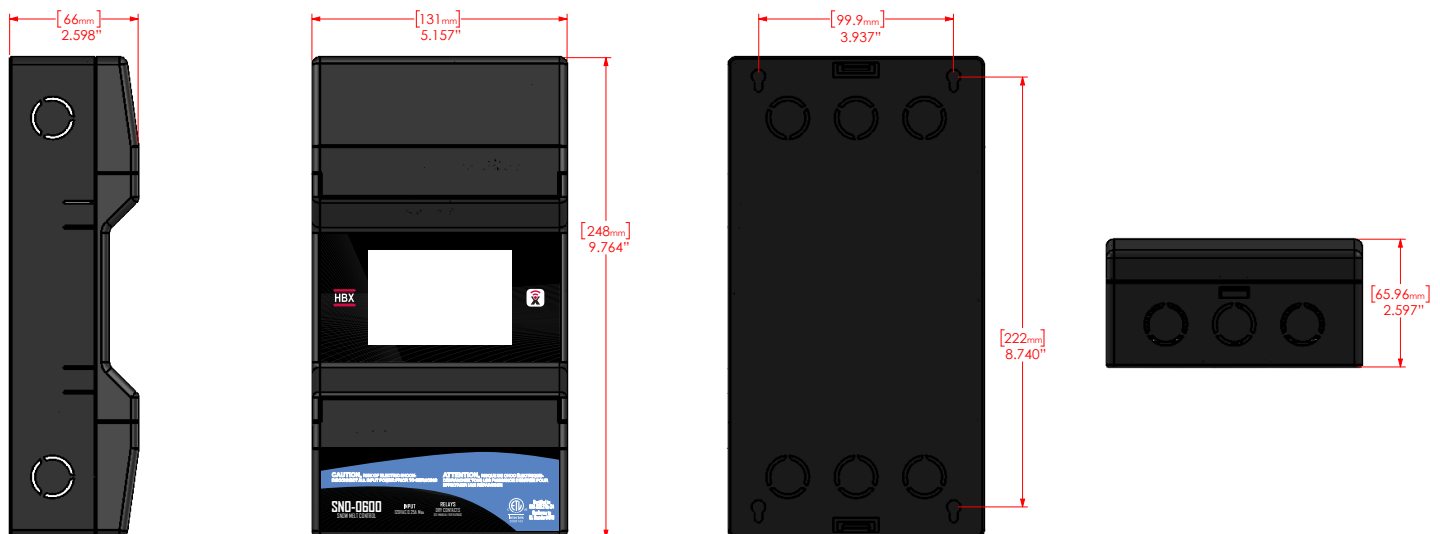



Tamas Hydronic Panels 400 000 BTU Snow Melt Submittal Warranty

Limited Warranty

Tamas Hydronic Systems Inc. warrants each of its products to be free from defects in workmanship and materials under normal use and service for a period of 24 months from date of purchase from a Tamas Hydronic Systems inc. authorized Dealer.

If the product proves to be defective within the applicable warranty period, Tamas Hydronic Systems inc. on its sole discretion will repair or replace said product. Replacement product may be new or refurbished of equivalent or better specifications, relative to the defective product. Replacement product need not be of identical design or model. Any repair or replacement product pursuant to this warranty shall be warranted for not less than 90 days from date of such repair, irrespective of any earlier expiration of original warranty period. When Tamas Hydronic Systems Inc. Provides replacement, the defective product becomes the property of Tamas Hydronic Systems Inc.

Warranty Service, within the applicable warranty period, may be obtained by contacting your nearest Tamas Hydronics Systems inc. office via the original Authorized Agent and requesting a Return Material Authorization Number (RMA #). Proof of purchase in the form a dated invoice/receipt must be provided to expedite the issuance of a Factory RMA.

After an RMA number has been issued, the defective product must be packaged securely in the original or other suitable shipping package to ensure that it will not be damaged in transit. The RMA number must be visible on the outside of the package and a copy included inside the package. The package must be mailed or otherwise shipped back to Tamas Hydronic Systems Inc. with all costs of mailing/shipping/insurance prepaid by the warranty claimant.

Any package/s returned to Tamas Hydronic Systems Inc. without an approved and visible RMA number will be rejected and shipped back to purchaser at purchaser's expense. Tamas Hydronic Systems Inc. Reserves the right, if deemed necessary, to charge a reasonable levy for costs incurred, additional to mailing or shipping costs.

Limitation of Warranties.

If the Tamas Hydronic Systems Inc. product does not operate as warranted above the purchasers sole remedy shall be, at Tamas Hydronic Systems Inc.' s option, repair or replacement. The foregoing warranties and remedies are exclusive and in lieu of all other warranties, expressed or implied, either in fact or by operation of law, statutory or otherwise, including warranties of merchantability and fitness for a particular purpose/application. Tamas Hydronic Systems Inc. neither assumes nor authorizes any other person to assume for it any other liability in connection with the sale, installation maintenance or use of Tamas Hydronic Systems Inc. products.

Tamas Hydronic Systems Inc. shall not be liable under this warranty; if its testing and examination discloses that the alleged defect in the product does not exist or was caused by the purchasers or third persons misuse, neglect, improper installation or testing, unauthorized attempts to repair or any other cause beyond the range of intended use, or by accident, fire, lightning or other hazard.

Limitation of Liability.

In no event will Tamas Hydronic Systems Inc. be liable for any damages, including loss of data, loss of profits, costs of cover or other incidental, consequential or indirect damages arising out of the installation, maintenance, commissioning, performance, failure or interruption of a Tamas Hydronic Systems Inc. product, however caused and on any theory of liability. This limitation will apply even if Tamas Hydronic Systems Inc. has been advised of the possibility of such damage.

Local Law.

This limited warranty statement gives the purchaser specific legal rights. The purchaser may also have other rights which vary from state to state in the United States, from Province to Province in Canada and from Country to Country elsewhere in the world.

To the extent this Limited Warranty Statement is inconsistent with local law, this statement shall be deemed modified to be consistent with such local law. Under such local law, certain disclaimers and limitations of this statement may not apply to the purchaser. For example, some states in the United States, as well as some governments outside the United States (including Canadian Provinces), may:

Preclude the disclaimers and limitations in this statement from limiting the statutory rights of a consumer (e.g. United Kingdom);

Otherwise restrict the ability of a manufacturer to enforce such disclaimers or limitations; or

Grant the purchaser additional warranty rights which the manufacturer cannot disclaim, or not allow limitations on the duration of implied warranties.