



| | |
|---|---------|
| Job or Customer : | |
| Location : | |
| Engineer : | |
| <input type="checkbox"/> Complies with Spec <input type="checkbox"/> Alternate | Notes : |
| Contractor : | |
| Tamas Rep : | |
| Submitted By : | Date : |
| Approved By : | Date : |
| P.O. Number : | Date : |

Description

The Tamas Zone No Mixing Manifold System provides a System pump and a manifold for the distribution of mixed water for each of the zones.

Nominal Panel Output

Options: B - BMS Compatible S - Stainless Steel

| Qty | Model # | Options | Description |
|-----|--------------|---|--|
| | T-ZM-00-0021 | B <input type="checkbox"/> S <input type="checkbox"/> | Zone Manifold Panel with (2) Loops, (1) System Pump 0015e3 and Galvanized Enclosure |
| | T-ZM-00-0031 | B <input type="checkbox"/> S <input type="checkbox"/> | Zone Manifold Panel with (3) Loops, (1) System Pump 0015e3 and Galvanized Enclosure |
| | T-ZM-00-0041 | B <input type="checkbox"/> S <input type="checkbox"/> | Zone Manifold Panel with (4) Loops, (1) System Pump 0015e3 and Galvanized Enclosure |
| | T-ZM-00-0051 | B <input type="checkbox"/> S <input type="checkbox"/> | Zone Manifold Panel with (5) Loops, (1) System Pump 0015e3 and Galvanized Enclosure |
| | T-ZM-00-0061 | B <input type="checkbox"/> S <input type="checkbox"/> | Zone Manifold Panel with (6) Loops, (1) System Pump 0015e3 and Galvanized Enclosure |
| | T-ZM-00-0071 | B <input type="checkbox"/> S <input type="checkbox"/> | Zone Manifold Panel with (7) Loops, (1) System Pump 0015e3 and Galvanized Enclosure |
| | T-ZM-00-0081 | B <input type="checkbox"/> S <input type="checkbox"/> | Zone Manifold Panel with (8) Loops, (1) System Pump 0015e3 and Galvanized Enclosure |
| | T-ZM-00-0091 | B <input type="checkbox"/> S <input type="checkbox"/> | Zone Manifold Panel with (9) Loops, (1) System Pump 0015e3 and Galvanized Enclosure |
| | T-ZM-00-0101 | B <input type="checkbox"/> S <input type="checkbox"/> | Zone Manifold Panel with (10) Loops, (1) System Pump 0015e3 and Galvanized Enclosure |
| | T-ZM-00-0111 | B <input type="checkbox"/> S <input type="checkbox"/> | Zone Manifold Panel with (11) Loops, (1) System Pump 0015e3 and Galvanized Enclosure |
| | T-ZM-00-0121 | B <input type="checkbox"/> S <input type="checkbox"/> | Zone Manifold Panel with (12) Loops, (1) System Pump 0015e3 and Galvanized Enclosure |
| | T-ZM-00-0022 | B <input type="checkbox"/> S <input type="checkbox"/> | Zone Manifold Panel with (2) Loops, (1) System Pump 26-99 and Galvanized Enclosure |
| | T-ZM-00-0032 | B <input type="checkbox"/> S <input type="checkbox"/> | Zone Manifold Panel with (3) Loops, (1) System Pump 26-99 and Galvanized Enclosure |
| | T-ZM-00-0042 | B <input type="checkbox"/> S <input type="checkbox"/> | Zone Manifold Panel with (4) Loops, (1) System Pump 26-99 and Galvanized Enclosure |
| | T-ZM-00-0052 | B <input type="checkbox"/> S <input type="checkbox"/> | Zone Manifold Panel with (5) Loops, (1) System Pump 26-99 and Galvanized Enclosure |
| | T-ZM-00-0062 | B <input type="checkbox"/> S <input type="checkbox"/> | Zone Manifold Panel with (6) Loops, (1) System Pump 26-99 and Galvanized Enclosure |
| | T-ZM-00-0072 | B <input type="checkbox"/> S <input type="checkbox"/> | Zone Manifold Panel with (7) Loops, (1) System Pump 26-99 and Galvanized Enclosure |
| | T-ZM-00-0082 | B <input type="checkbox"/> S <input type="checkbox"/> | Zone Manifold Panel with (8) Loops, (1) System Pump 26-99 and Galvanized Enclosure |
| | T-ZM-00-0092 | B <input type="checkbox"/> S <input type="checkbox"/> | Zone Manifold Panel with (9) Loops, (1) System Pump 26-99 and Galvanized Enclosure |
| | T-ZM-00-0102 | B <input type="checkbox"/> S <input type="checkbox"/> | Zone Manifold Panel with (10) Loops, (1) System Pump 26-99 and Galvanized Enclosure |
| | T-ZM-00-0112 | B <input type="checkbox"/> S <input type="checkbox"/> | Zone Manifold Panel with (11) Loops, (1) System Pump 26-99 and Galvanized Enclosure |
| | T-ZM-00-0122 | B <input type="checkbox"/> S <input type="checkbox"/> | Zone Manifold Panel with (12) Loops, (1) System Pump 26-99 and Galvanized Enclosure |

Technical Data

Material:
 Backpan..... Galvanized Steel (Stainless Steel Optional)
 Lockable Enclosure..... Galvanized Steel (Stainless Steel Optional)
 Piping..... Copper/Stainless Steel

Max Ambient Temperature.....120°F (49°C)

Max Water Temperature..... 200°F (93°C)

Power Supply.....110V (AC) Max Current 6amp

Standards/Listings

- CSA C22.2 No. 14-95
- UL 598A
- ETL No. 3032227

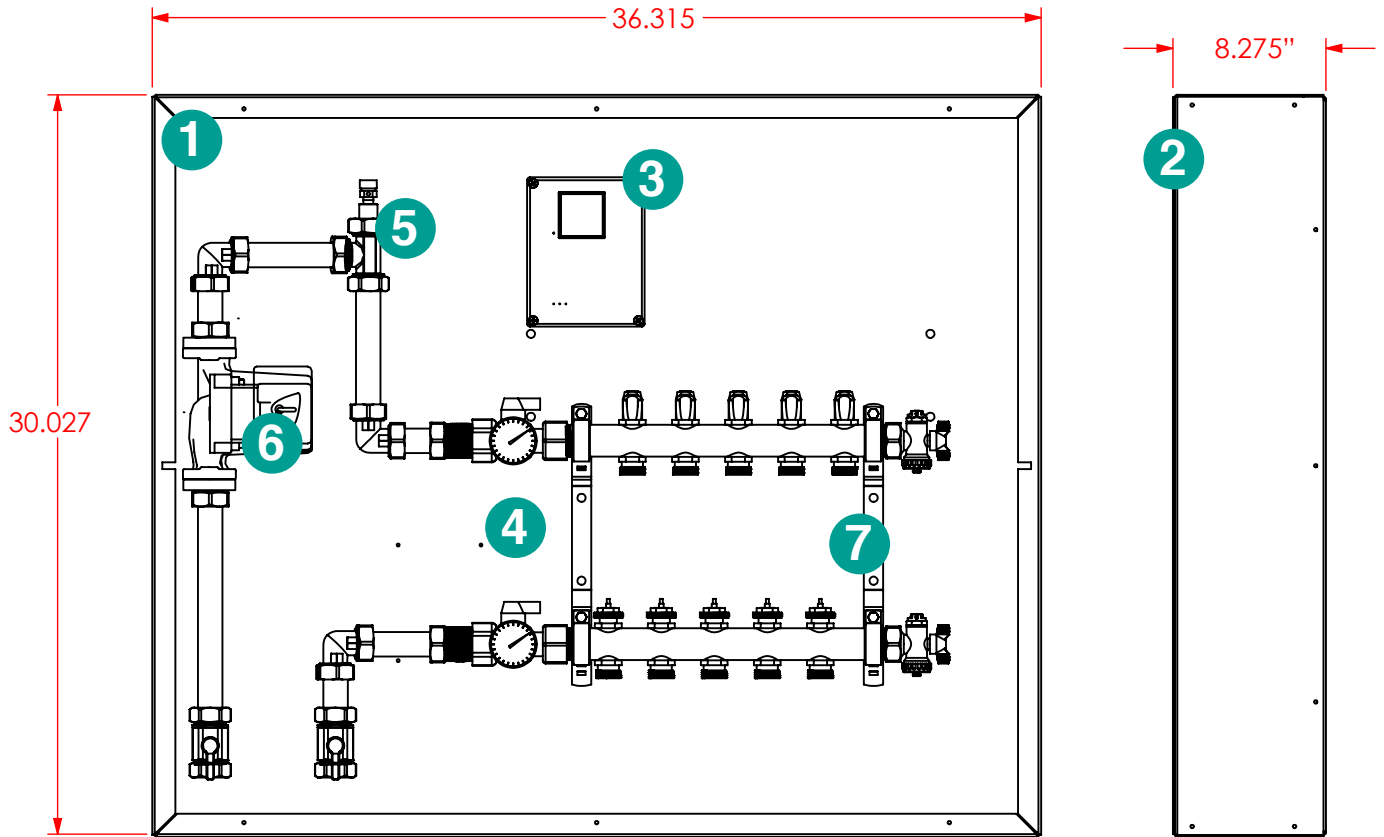

*Panels over 5 Zones will require a 47" x 30" Enclosure.
 5.62" Depth for Recessed panels.

| Part List | | | |
|-----------|---------------------------------------|---|---|
| 1 | <i>Stainless Steel Back Plate</i> | 5 | <i>Air Vent</i> |
| 2 | <i>Lockable Stainless Steel Cover</i> | 6 | <i>System Pump</i> |
| 3 | <i>Tamas Control Box</i> | 7 | <i>Stainless Steel Heating Manifold</i> |
| 4 | <i>Temperature Gauges</i> | | |

Taco 0015e3 Specifications

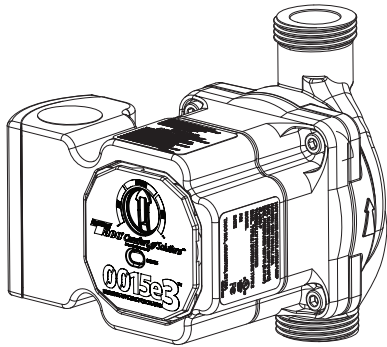
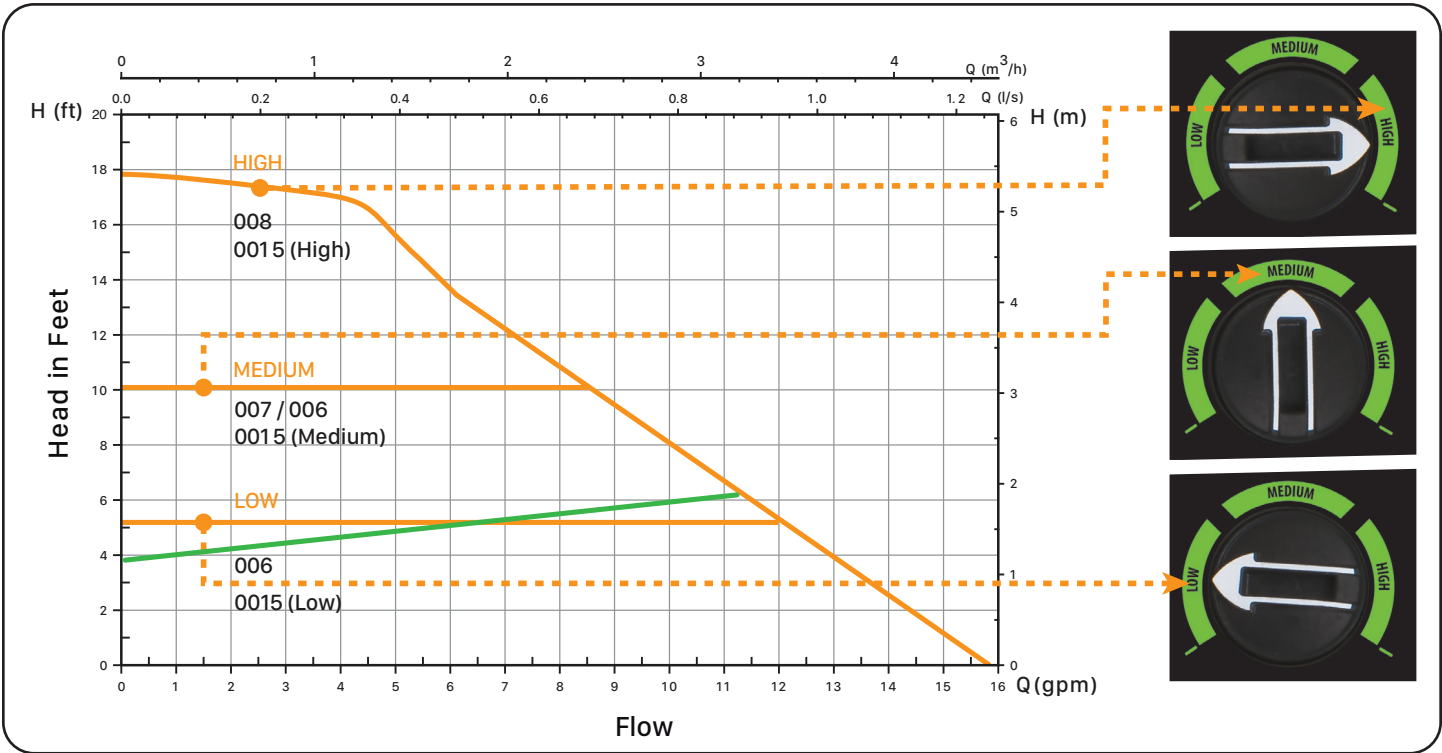

- Flow Range: 0-16 GPM
- Head Range (ft): 0-18'
- Max. Water Temp.: 230°F (110°C)
- Min. Water Temp.: 36°F (2°C)
- Voltage: 120V, 60 Hz Single phase
- Max. Operating Power: 44W
- Max. AMP Rating: 0.54

Electrical Data

| Model | Volts | Hz | Ph | Max. Amps | Max. Watts | RPM |
|------------|--|----|----|-----------|------------|-----------|
| All Models | 120 | 60 | 1. | 54 | 44 | 1590-4830 |
| Motor Type | ECM, Permanent Magnet, Thermally Protected | | | | | |

UPS 26-99 SFC Specifications

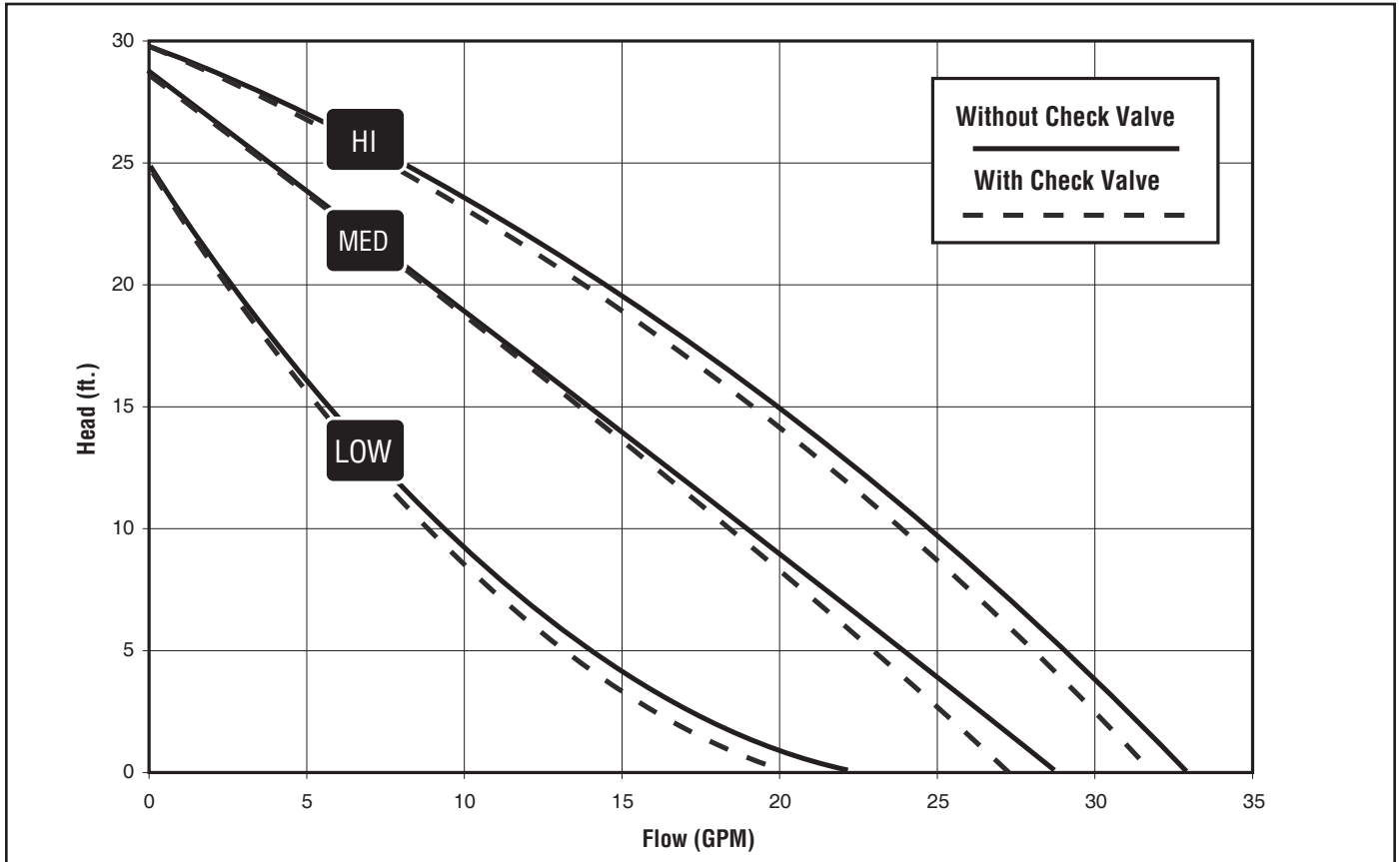

Flow range: 0 - 34 U.S. GPM
 Head range: 0 - 30 FEET
 Motors: 2 Pole, Single Phase
 Maximum fluid temperature: 230°F (110°C)
 Min. fluid temperature: 36°F (2°C)
 Maximum working pressure: 145 PSI

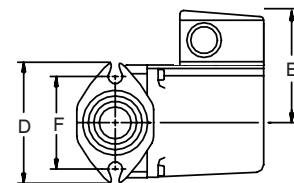
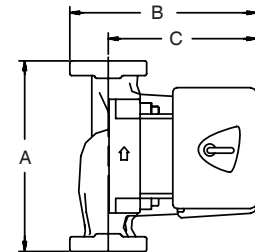

| MODEL | VOLTS | AMPS | WATTS | HP | CAPACITOR |
|-------|--------|------|-------|-----|-----------|
| 115V | Spd. 3 | 1.8 | 197 | 1/6 | 20mF/180V |
| | Spd. 2 | 1.5 | 179 | 1/6 | 20mF/180V |
| | Spd. 1 | 1.3 | 150 | 1/6 | 20mF/180V |

| Model Type | A | B | C | D | E | F | Connection Type and Size | Approximate Shipping Wt. (lbs) |
|---------------|-------|---|-------|-------|--------|--------|--|--------------------------------|
| UPS 26-99 SFC | 6 1/2 | 6 | 4 7/8 | 3 1/2 | 3 7/16 | 3 5/32 | GF 15/26 Flange - (2) 1/2" Dia. Bolt Holes | 10.3 |

Description

The 1/1 ¼" Stainless-steel Manifold Assembly with flow meter comes fully assembled. The included flow meters located on the supply manifold are used to balance the loops across the manifold. The return manifold comes equipped with isolation valves for easy loop isolation. For multiple zoning on the manifold, the black caps are removed and replaced with Thermal Actuators. The manifold body ends have R32 union connections and the loop outlets have R20 male threads. The included manifold supply and return ball valves come with an R32 x 1" NPT connection or R32 x 1 ¼" NPT Connection.

Technical Data

| | |
|--|--|
| Manifold Material: | Stainless steel AISI304 |
| Manifold Components: | Brass CW614N-UNI EN12164 CW617N-UNI EN12165 |
| Manifold Body Size (I.D.): | 1" <i>or</i> 1 ¼" |
| Manifold Assembly Loop Cv (flow with valve wide open): | 1.1 Cv |
| Manifold Body Threaded Connections: | R32 |
| Manifold Loop Threaded Connections: | R20 |
| Maximum Fluid Flow Rate: | 14 GPM <i>or</i> 21 GPM |
| Hydrostatic Temp/Pressure Rating: | 68°F (20°C) at 145 psi 158°F (70°C) at 87.4 psi 194°F (90°C) at 43.8 psi |

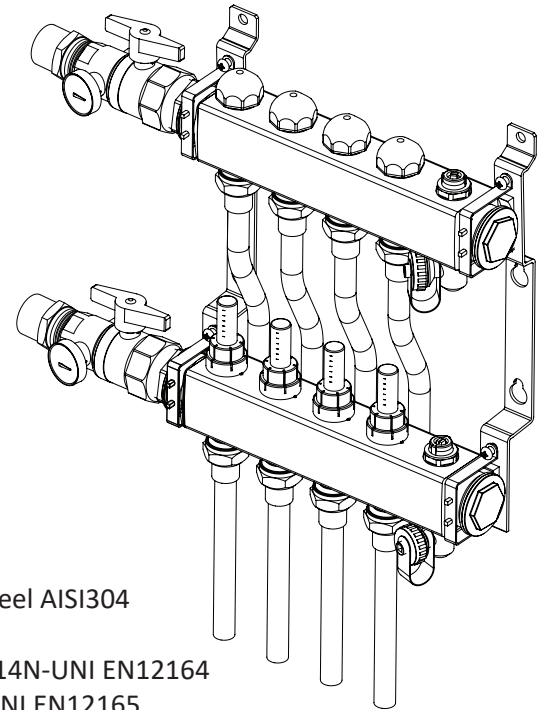



Limited Warranty

Tamas Hydronic Systems Inc. warrants each of its products to be free from defects in workmanship and materials under normal use and service for a period of 24 months from date of purchase from a Tamas Hydronic Systems inc. authorized Dealer.

If the product proves to be defective within the applicable warranty period, Tamas Hydronic Systems Inc. on its sole discretion will repair or replace said product. Replacement product may be new or refurbished of equivalent or better specifications, relative to the defective product. Replacement product need not be of identical design or model. Any repair or replacement product pursuant to this warranty shall be warranted for not less than 90 days from date of such repair, irrespective of any earlier expiration of original warranty period. When Tamas Hydronic Systems Inc. Provides replacement, the defective product becomes the property of Tamas Hydronic Systems Inc.

Warranty Service, within the applicable warranty period, may be obtained by contacting your nearest Tamas Hydronic Systems Inc. office via the original Authorized Agent and requesting a Return Material Authorization Number (RMA #). Proof of purchase in the form a dated invoice/ receipt must be provided to expedite the issuance of a Factory RMA.

After an RMA number has been issued, the defective product must be packaged securely in the original or other suitable shipping package to ensure that it will not be damaged in transit. The RMA number must be visible on the outside of the package and a copy included inside the package. The package must be mailed or otherwise shipped back to Tamas Hydronic Systems Inc. with all costs of mailing/shipping/insurance prepaid by the warranty claimant.

Any package(s) returned to Tamas Hydronic Systems Inc. without an approved and visible RMA number will be rejected and shipped back to purchaser at purchaser's expense. Tamas Hydronic Systems Inc. reserves the right, if deemed necessary, to charge a reasonable levy for costs incurred, additional to mailing or shipping costs.

Limitation of Warranties

If the Tamas Hydronic Systems Inc. product does not operate as warranted above the purchasers sole remedy shall be, at Tamas Hydronic Systems Inc.' s option, repair or replacement. The foregoing warranties and remedies are exclusive and in lieu of all other warranties, expressed or implied, either in fact or by operation of law, statutory or otherwise, including warranties of merchantability and fitness for a particular purpose/application. Tamas Hydronic Systems Inc. neither assumes nor authorizes any other person to assume for it any other liability in connection with the sale, installation maintenance or use of Tamas Hydronic Systems Inc. products.

Tamas Hydronic Systems Inc. shall not be liable under this warranty; if its testing and examination discloses that the alleged defect in the product does not exist or was caused by the purchasers or third persons misuse, neglect, improper installation or testing, unauthorized attempts to repair or any other cause beyond the range of intended use, or by accident, fire, lightning or other hazard.

Limitation of Liability

In no event will Tamas Hydronic Systems Inc. be liable for any damages, including loss of data, loss of profits, costs of cover or other incidental, consequential or indirect damages arising out of the installation, maintenance, commissioning, performance, failure or interruption of a Tamas Hydronic Systems Inc. product, however caused and on any theory of liability. This limitation will apply even if Tamas Hydronic Systems Inc. has been advised of the possibility of such damage.

Local Law

This limited warranty statement gives the purchaser specific legal rights. The purchaser may also have other rights which vary from state to state in the United States, from Province to Province in Canada and from Country to Country elsewhere in the world.

To the extent this Limited Warranty Statement is inconsistent with local law, this statement shall be deemed modified to be consistent with such local law. Under such local law, certain disclaimers and limitations of this statement may not apply to the purchaser. For example, some states in the United States, as well as some governments outside the United States (including Canadian Provinces), may:

1. Preclude the disclaimers and limitations in this statement from limiting the statutory rights of a consumer (e.g. United Kingdom);
2. Otherwise restrict the ability of a manufacturer to enforce such disclaimers or limitations; or
3. Grant the purchaser additional warranty rights which the manufacturer cannot disclaim, or not allow limitations on the duration of implied warranties.